

COLONIAL CASTINGS

EST 1947

Safety Screens Doors & Grilles

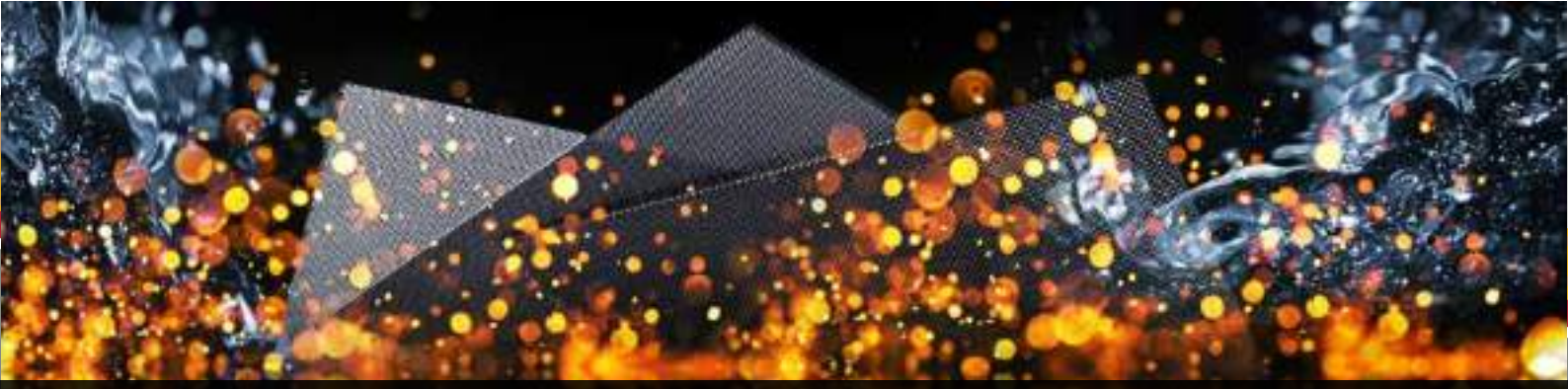

Stunning Hinged Doors

WITH GLASS INSERTS

GLASS INSERT COLOUR OPTIONS:
TEAL BLUE
OLIVE GREEN

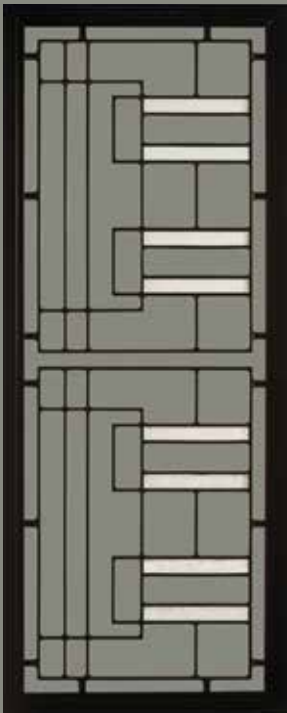

SP65AB RICE PAPER GLASS

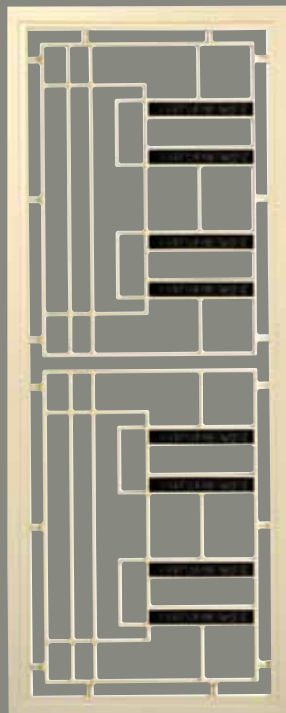

SP65AB BLACK GLASS

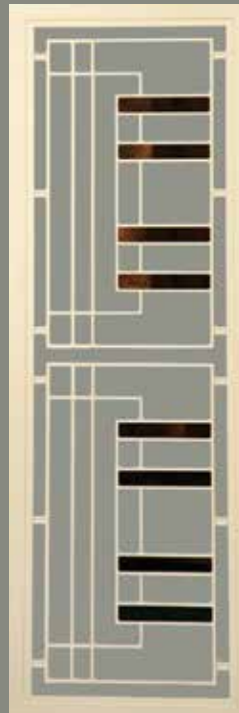

SP69 BLACK GLASS
Side Light French Door: 2 per door

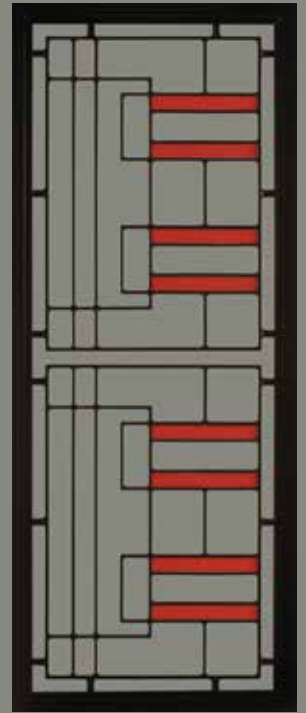

SP65AB RED GLASS

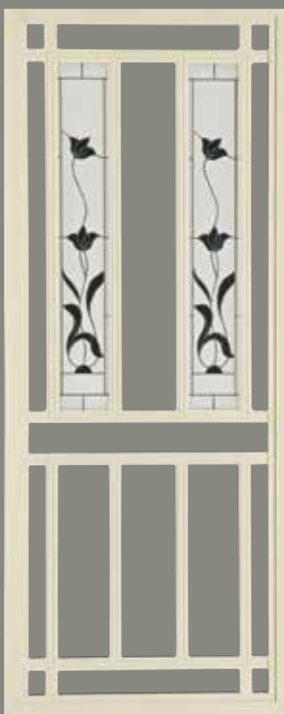

SP61AB BLACK ORCHID

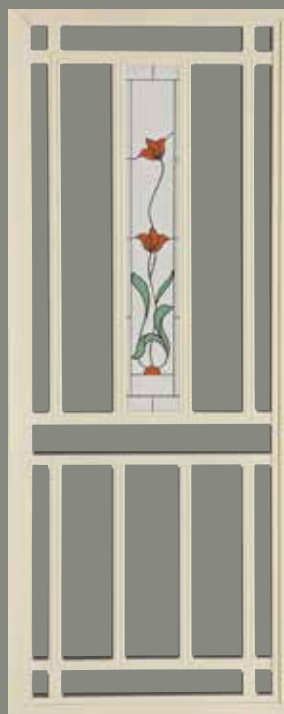

SP62AB RED ORCHID

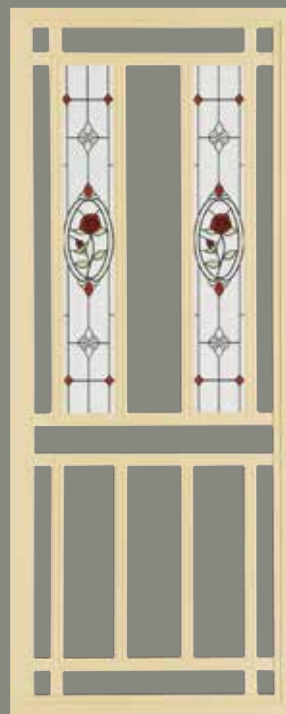

SP61AB ROSE JEWEL

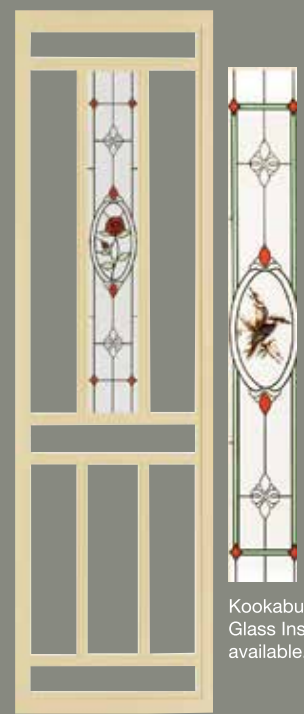

SP68 AB ROSE JEWEL



Kookaburra
Glass Insert
available.

These glass panel doors feature elegant decorative designs embossed on glass panels.
To clean simply wipe over with a damp cloth, avoid all acid based cleaners.

Side light

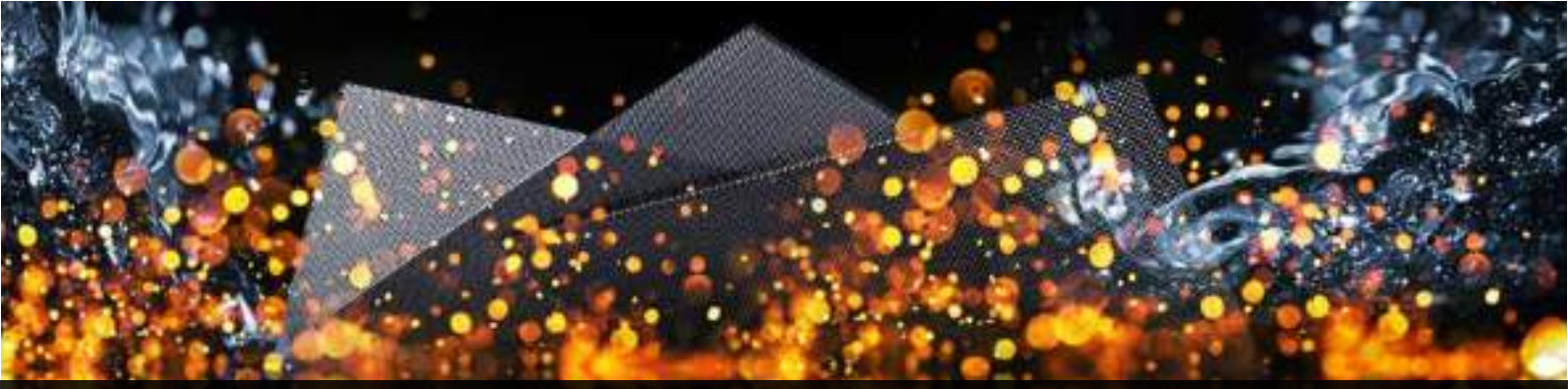

Stunning Hinged Doors

ART DECO RANGE

CHOICE OF COLOURED DISC INSERTS

- Bright Red
- Bistro Orange
- Satin Black
- French Blue

* Colours for illustration purposes only

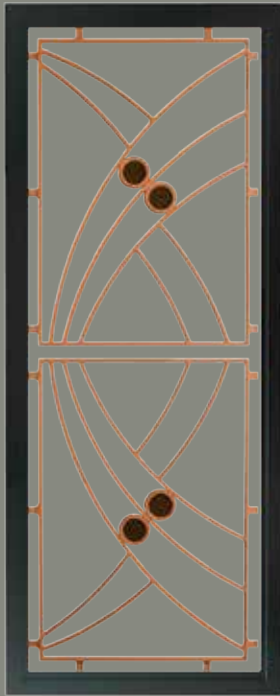

SP71AB ART DECO ORANGE

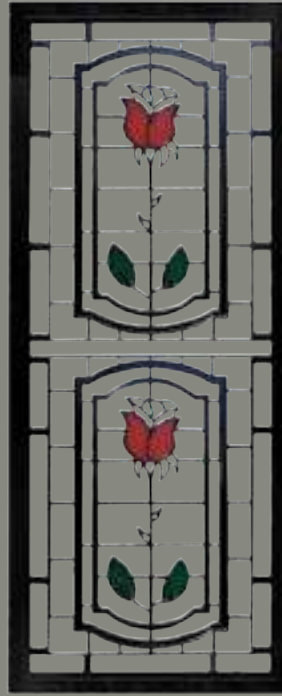

SP75AB

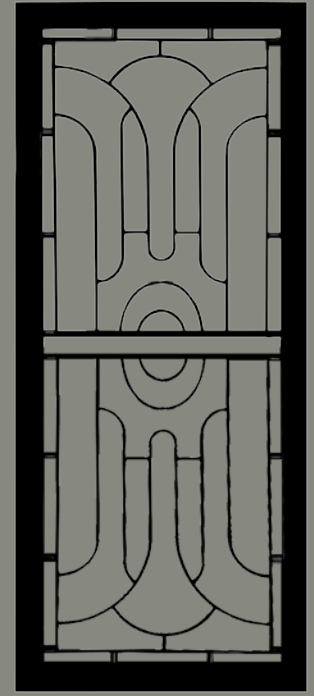

SP79 2 PER DOOR



SP34AB

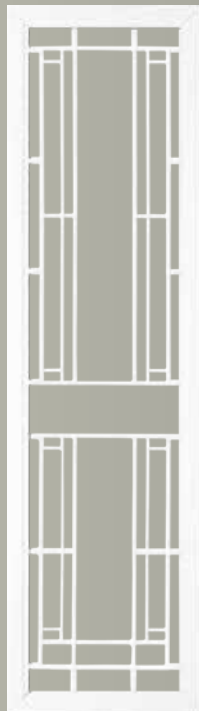

SP35AB

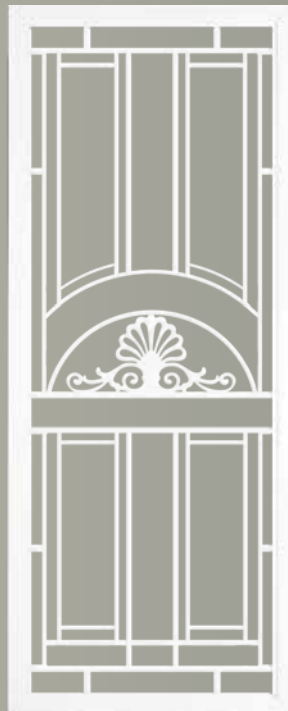

SP14AB



SP18AB



SP78AB

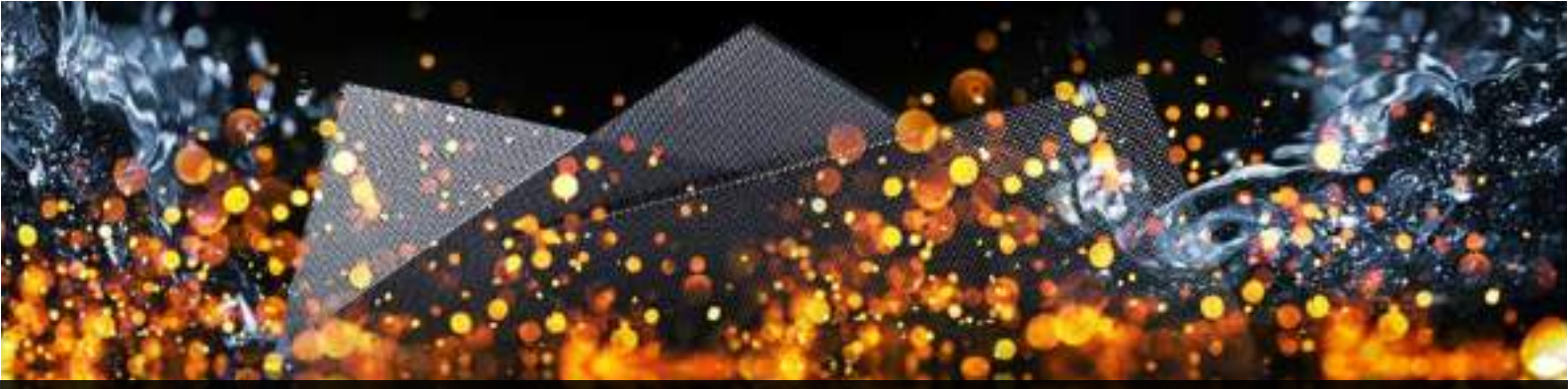

Stunning Hinged Doors

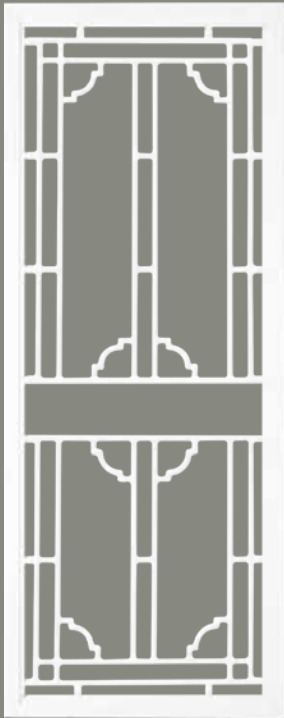

SP27AB



SP28AB

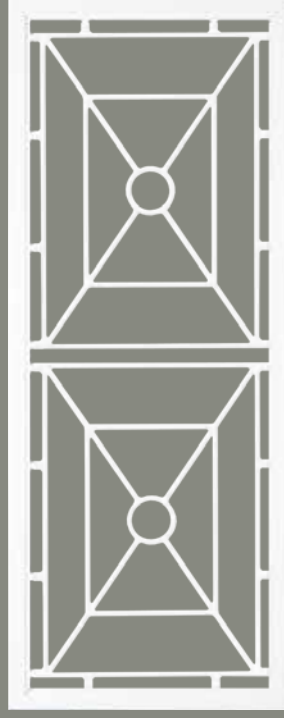

SP30
2 per door

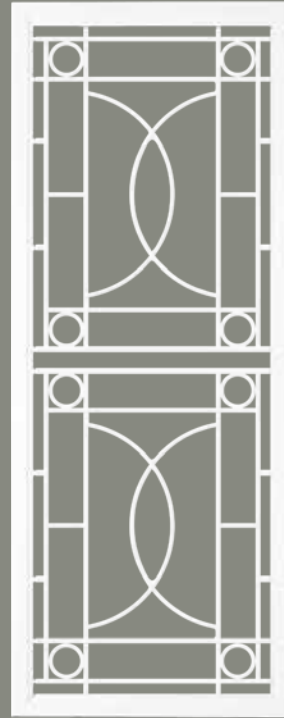

SP17
2 per door

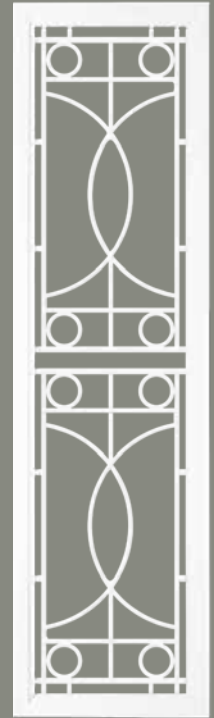

SP36
2 per door

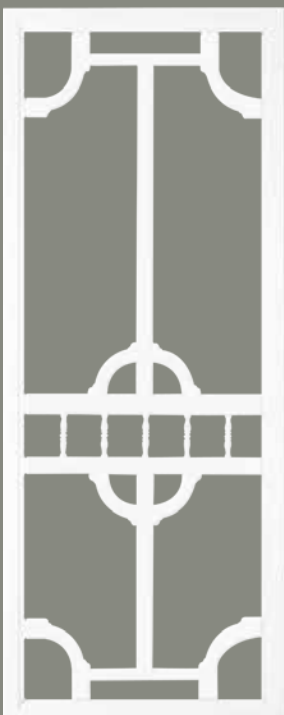

SP37AB



SP52
2 per door



SP53
2 per door



SP50AB

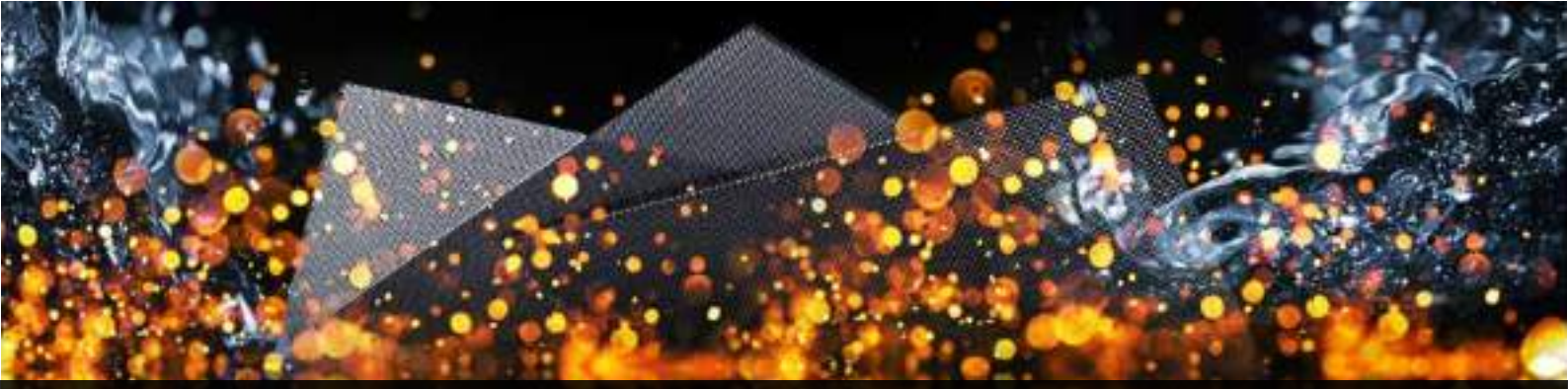

Stunning Hinged Doors

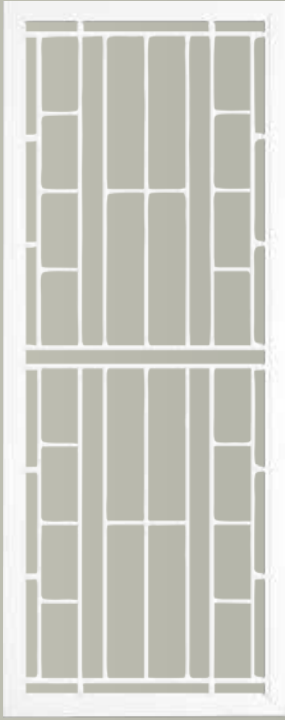

SP13BB
2 per door



SP16BB
2 per door

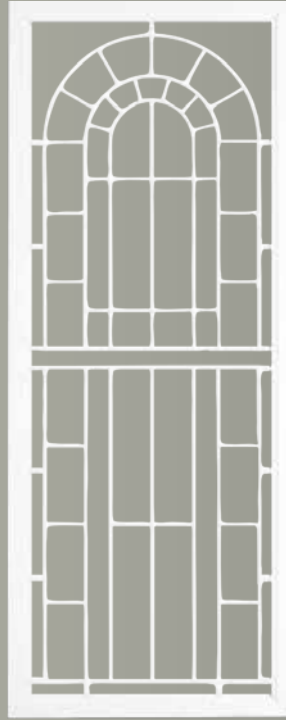

SP13AB



SP16AB

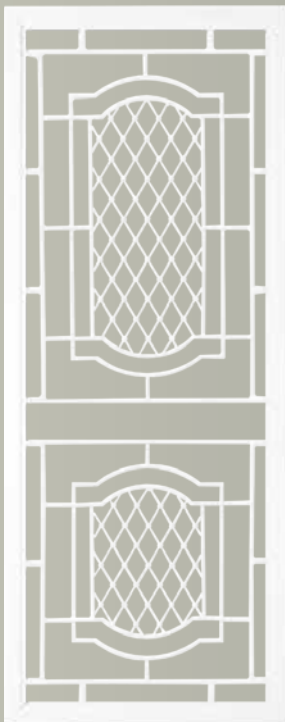

SP44AB



SP45AB

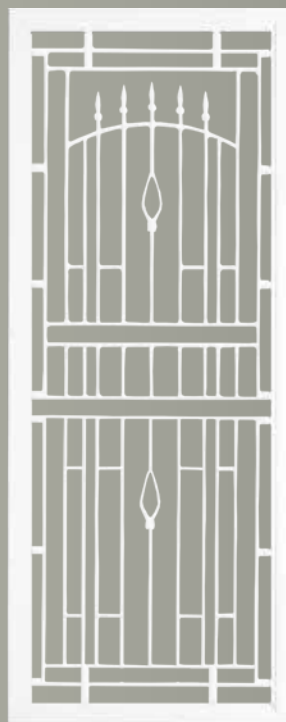

SP29AB



SP31AB

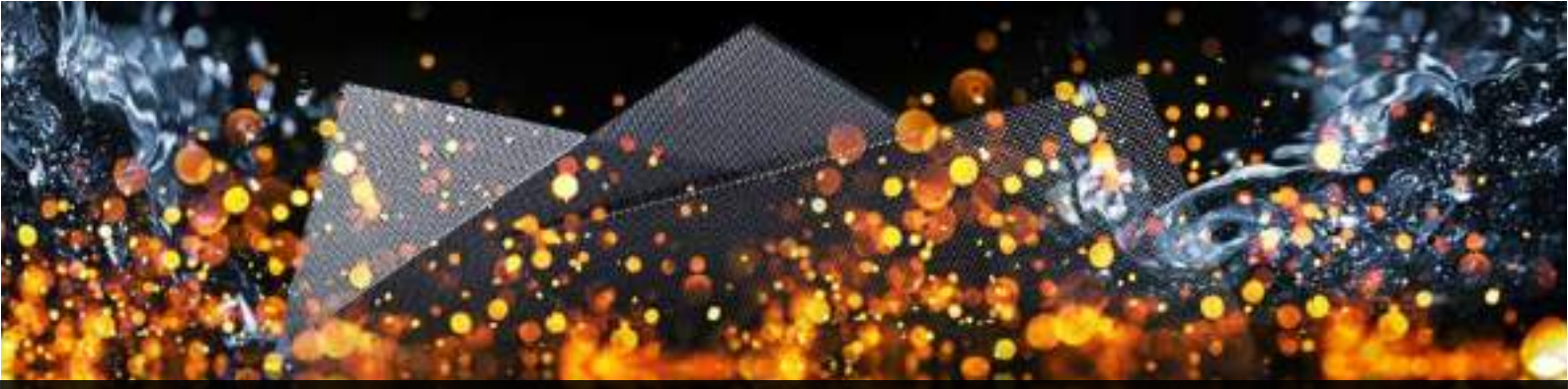

Elegant Hinged Doors

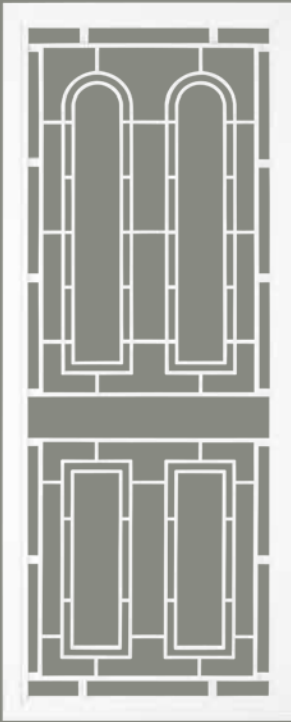

SP51AB



SP56
2 per door

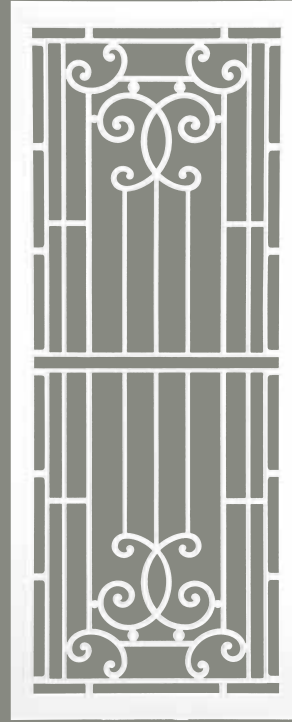

SP55
2 per door



SP57AB



SP6
2 per door

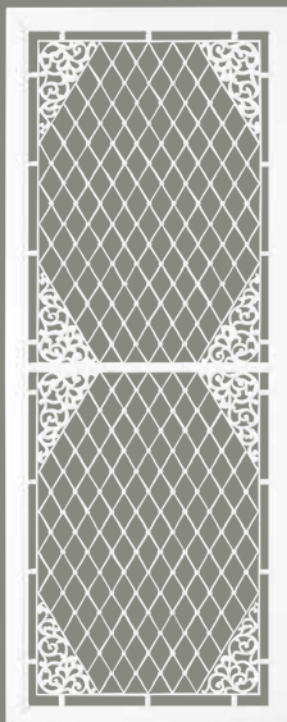

SP10
2 per door



SP21
2 per door

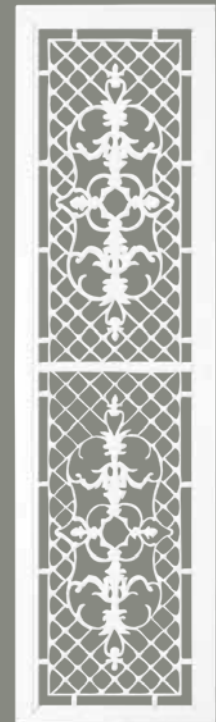

SP22
2 per door

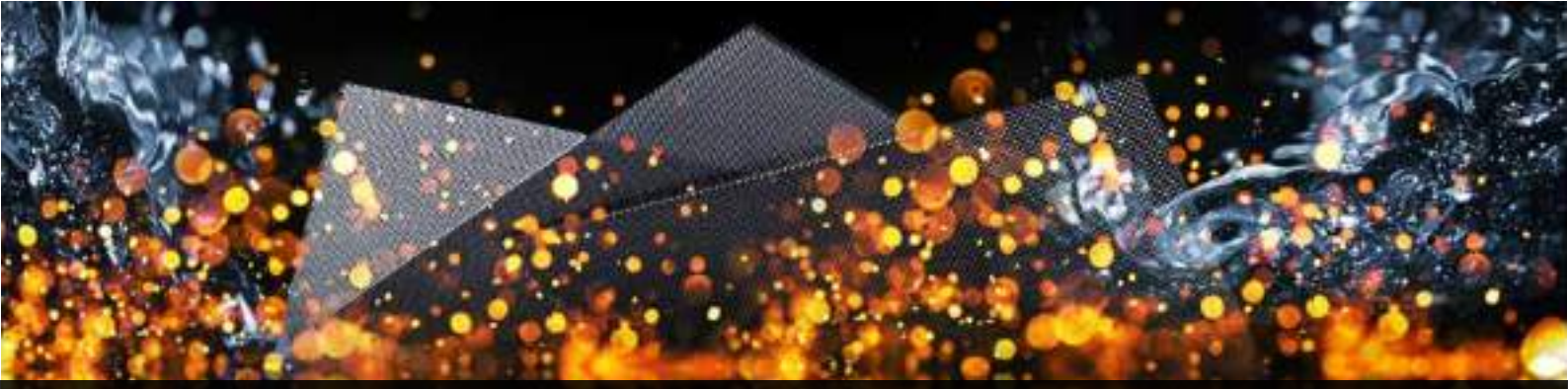

Security Mesh Doors



GALVANISED MESH

GALVANISED MESH SP70

Woven Galvanised Mesh:

- Features:**
- Small holes
 - Powder coated black galvanised mesh
 - Spacer available for ease of fixing using pop rivets
 - Suits hinge and sliding doors windows and screens

Passed Impact Test AS5041-2003
 Passed Lock and Hinge Test AS5041-2003
 Passed Australian Sheer Test AS5041
 Powder coated black OR Stainless Steel

Standard sizes: 2.0mm thick
 750 x 2400mm
 900 x 2400mm
 1200 x 2400mm

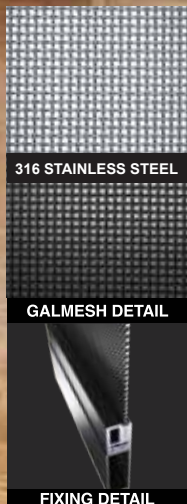

2MM PUNCHED ALUMESH

ALUMESH SP67

2mm Punched Aluminium

- Features:**
- Small holes
 - Powder coated black
 - Spacer available for ease of fixing using pop rivets
 - Suits hinge and sliding doors windows and screens

Passed Impact Test AS5041-2003
 Passed Lock and Hinge Test AS5041-2003
 Passed Australian Sheer Test AS5041
 Powder coated black

Standard sizes: 2.0mm thick
 750 x 2400mm
 900 x 2400mm
 1200 x 2400mm

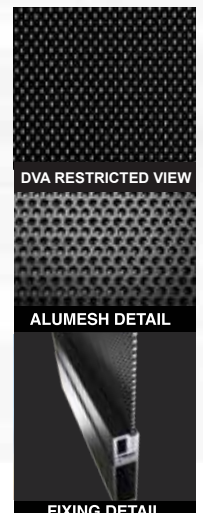

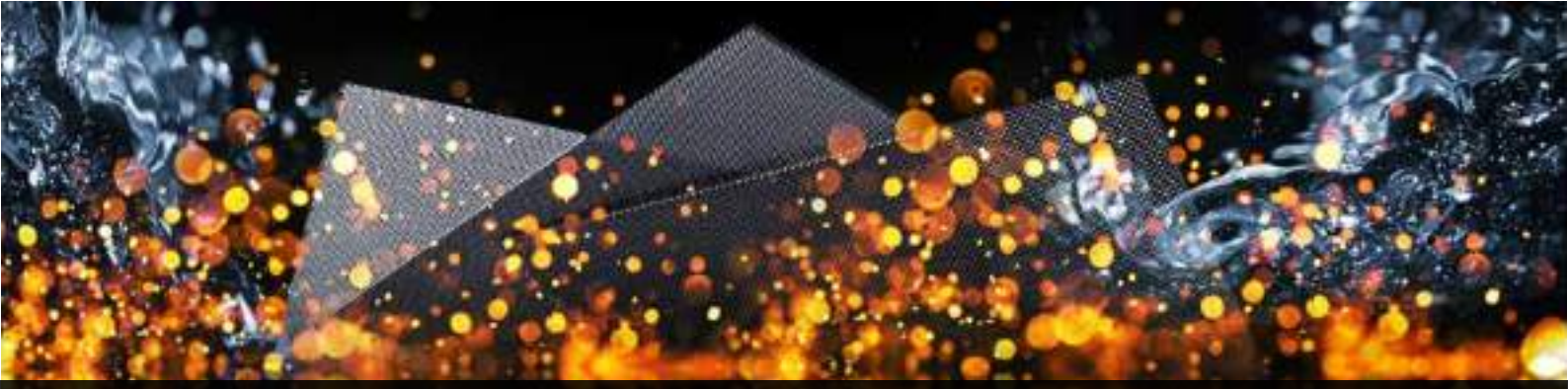

Safety & Security Doors

ADD A TOUCH OF CLASS TO YOUR ENTRANCE

The strength and security of 2mm Punched Aluminium mesh in combination with aluminium decorative panel attached, gives you safety and a very attractive appearance for your main entry.

Our decorative cast panels are available in our full range of colours to choose from.

Aluminium punched mesh is also available in 2 colours: **BLACK OR GULL GREY.**

The cast panels are chemically attached to the aluminium mesh then riveted on the back with stainless steel rivets.

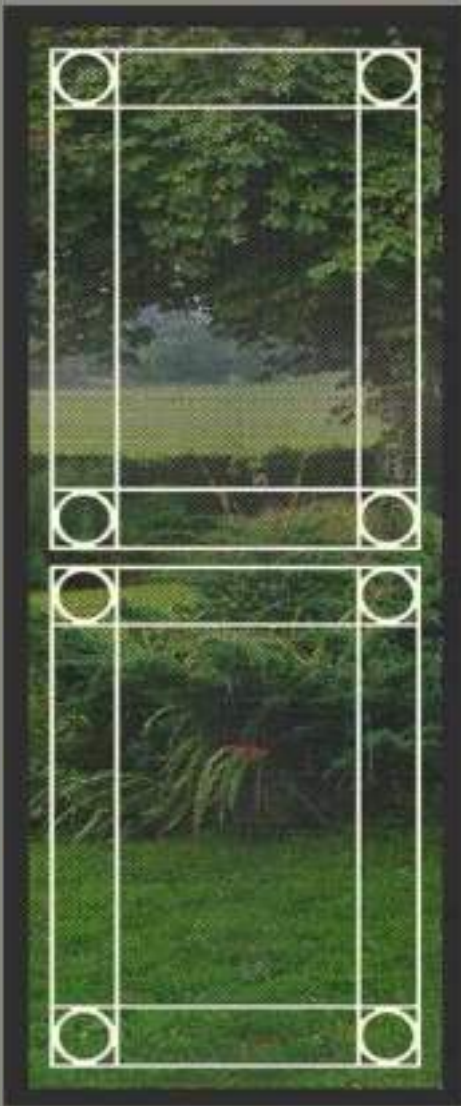

BLACK MESH SP73

Passed Impact Test AS5041-2003
Passed Lock and Hinge Test AS5041-2003
Passed Australian Sheer Test AS5041
Powder coated black or Gull Grey

Standard sizes: 2.0mm thick
750 x 2000mm
900 x 2000mm
1200 x 2000mm

Larger sizes available on application.

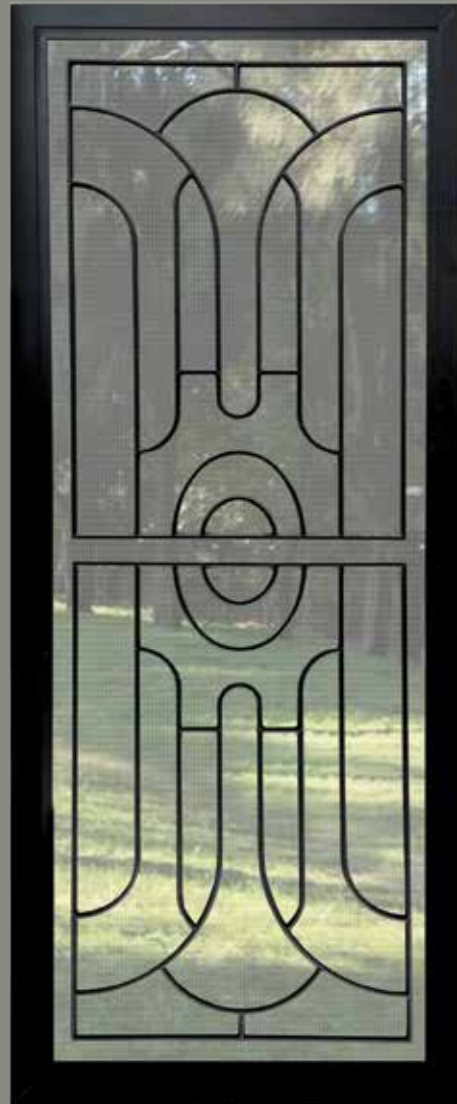

GULL GREY MESH SP81

Passed Impact Test AS5041-2003
Passed Lock and Hinge Test AS5041-2003
Passed Australian Sheer Test AS5041
Powder coated black or Gull Grey

Standard sizes:
750 x 2000mm
900 x 2000mm
1200 x 2000mm

Larger sizes available on application.



Safety & Security Doors

ADD A TOUCH OF CLASS TO YOUR ENTRANCE



GULL GREY MESH SP74

Passed Impact Test AS5041-2003
Passed Lock and Hinge Test AS5041-2003
Passed Australian Sheer Test AS5041
Powder coated black or Gull Grey

Standard sizes:
750 x 2000mm
900 x 2000mm
1200 x 2000mm

Larger sizes available on application.



GULL GREY MESH SP72

Passed Impact Test AS5041-2003
Passed Lock and Hinge Test AS5041-2003
Passed Australian Sheer Test AS5041
Powder coated black or Gull Grey

Standard sizes:
750 x 2000mm
900 x 2000mm
1200 x 2000mm

Larger sizes available on application.

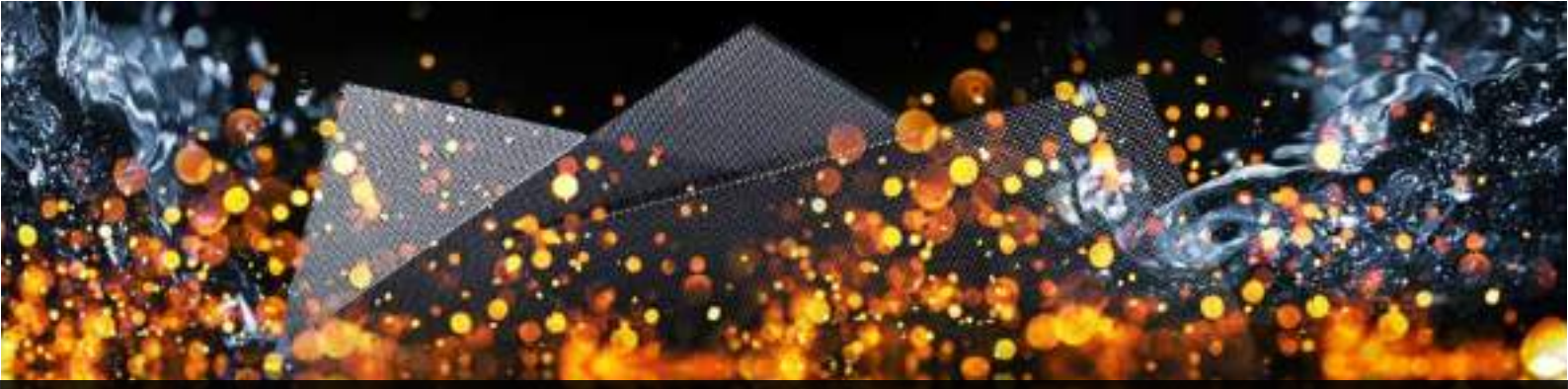

Sliding Doors

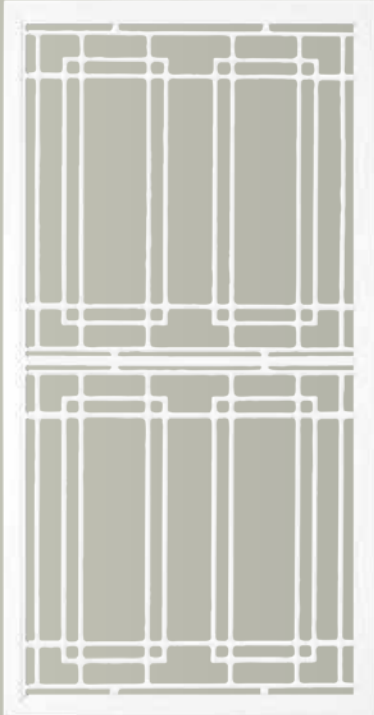

SP48S* 2 per door



SP14S*/SP15B*

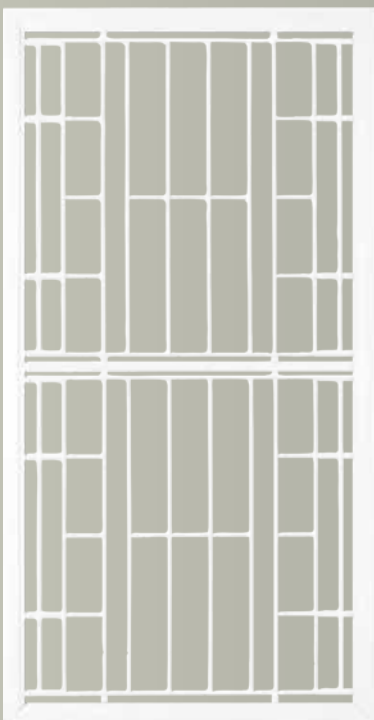

SP15BB* 2 per door

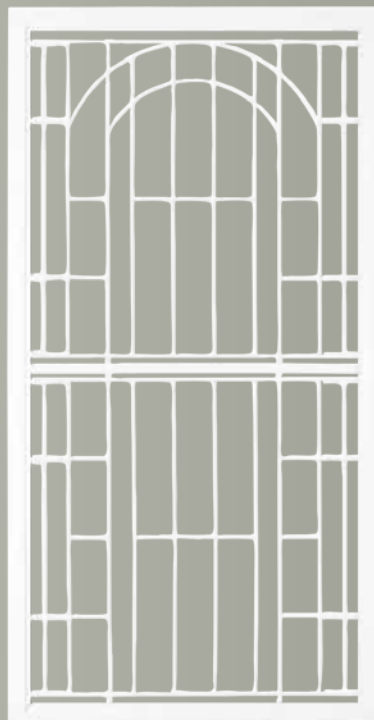

SP15AB*



CC2075

HINGED BARRIER DOOR LOCK

The CC2075 hinged barrier door lock is made from a zinc die cast body with stainless steel strikes providing the highest level of protection for hinged screen doors.

Features

- Contemporary styled furniture
- Non handed furniture - suits left handed and right handed doors
- 3 point kits for additional security available
- Fits industry standard cut outs
- Zinc diecast lock mechanism and furniture
- Mortice lock inside snib
- Accepts Euro profile lazy cam cylinder
- Suit standard 20mm door thickness
- Tested & exceeds Australian & New Zealand AS4145 standard

HOW TO ORDER CC2075 BARRIER HINGED DOOR FURNITURE

CC2075 / SB
.....
Furniture Finish

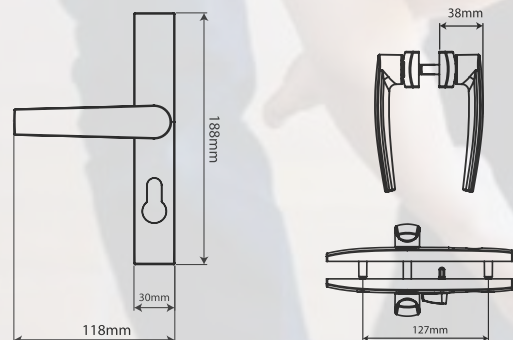

TECHNICAL SPECIFICATIONS

Materials:	Zinc Diecast
Finishes Available:	Black, White, Primrose
Keying:	Euro profile lazy cam cylinder locks CC186, CC198

A Wide Colour Range

To capture that added touch of personal style and individuality we offer you a wide choice of colours in a hardy powder coated finish.

Finished Colour Options

Primrose
APO Grey
Magnolia
Notre Dame
Black (Night Sky)
Mist Green (Pale Eucalypt)
Slate Grey (Woodland Grey)
Claret
Birch White

White
Brown
Pottery
Hawthorn Green
Paper Bark (Marino)
Mountain Blue (Deep Ocean)
Bronze
Stone Beige
Heritage Green

On Request:

Silver
Surfmist
Anotec Dark Grey
Charcoal
Dune

Quality Materials

All door inserts are gravity die cast in 100% recyclable aluminium which does not rust and is known for its durability and strength. All door frames are constructed from extruded aluminium.

Caring for your Doors & Screens

To extend the life of your surface we recommend doors should be washed down regularly, especially in salt water environments. Avoid all acid based cleaners.



COLONIAL CASTINGS

EST 1947

95-97 Market Street
Smithfield NSW 2164

P: (02) 9604 8222
F: 1300 652 292

E: info@colonialcastings.com.au